

# REED SWITCH

## ORD221

Miniature offset-type

### ■ GENERAL DESCRIPTION

The ORD221 is a small single-contact reed switch designed for general control of medium-level loads less than 100V. The contacts are sealed within the glass tube with inert gas to maintain contact reliability.

### ■ FEATURES

- (1) Hermetically sealed within a glass tube with inert gas, reed contacts are not influenced by the external atmospheric environment.
- (2) Quick response
- (3) Comprising of operating parts and electrical parts arranged coaxially, reed switches are suited to high-frequency applications.
- (4) Compact and light weight.
- (5) Superior corrosion resistance and wear resistance of the contacts assures stable switching operation and long life.
- (6) Economically and easily becomes a proximity switch when paired with a magnet.

### ■ EXTERNAL DIMENSIONS (Unit: mm)

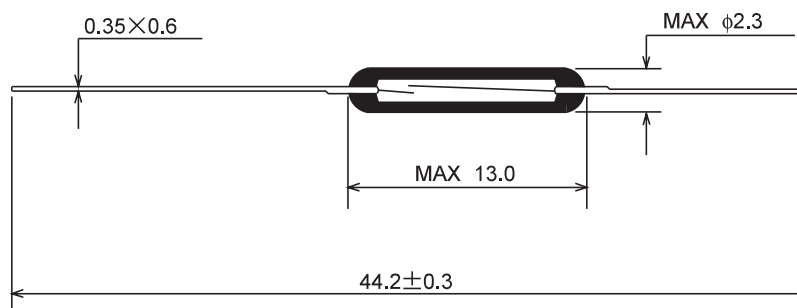

### ■ APPLICATIONS

- Automotive electronic devices
- Control equipment
- Communication equipment
- Measurement equipment
- Household appliances

■ ELECTRICAL CHARACTERISTICS

Parameter	Rated Value	Unit
Pull-in Value (PI)	10~30	AT
Drop-out Value (DO)	5min	AT
Contact Resistance (CR)	100max	mΩ
Breakdown Voltage	200 min (PI ≥ 20)	VDC
	150min (10 ≤ PI < 20)	VDC
Insulation Resistance	10 <sup>9</sup> min	Ω
Electrostatic Capacitance	0.3max	pF
Contact Rating	10	VA
Maximum Switching Voltage	100 (DC/AC)	V
Maximum Switching Current	0.3	A
Maximum Carry Current	1.0	A

3

(1) Pull-in Value vs. Drop-out Value

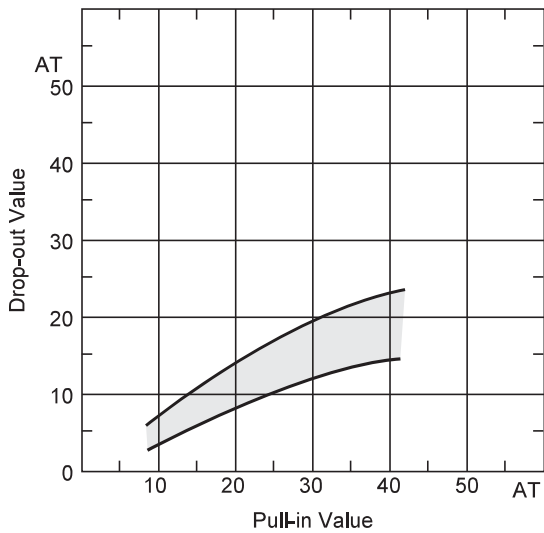

(2) Contact Resistance

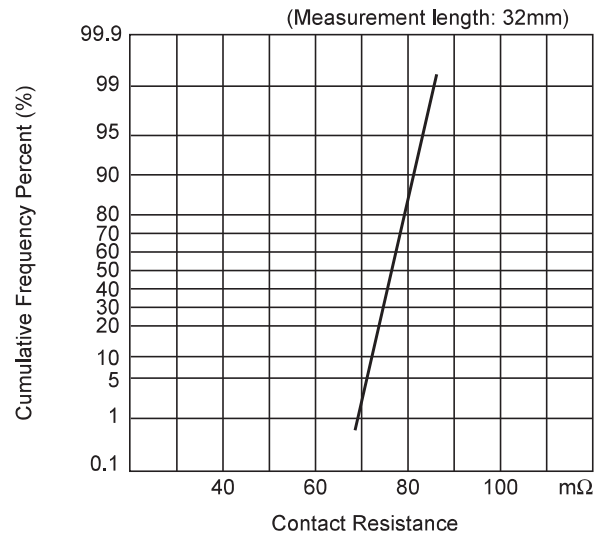

(3) Breakdown Voltage

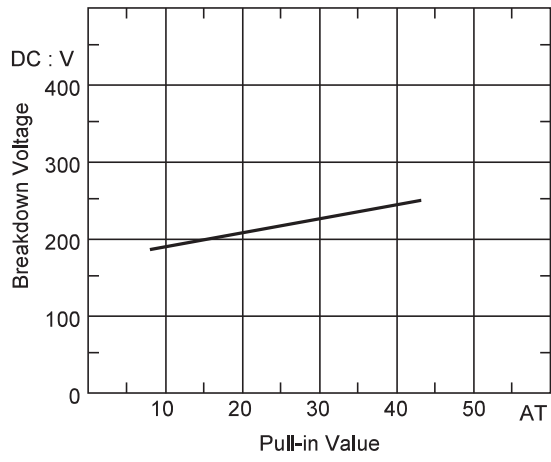

(4) Insulation Resistance

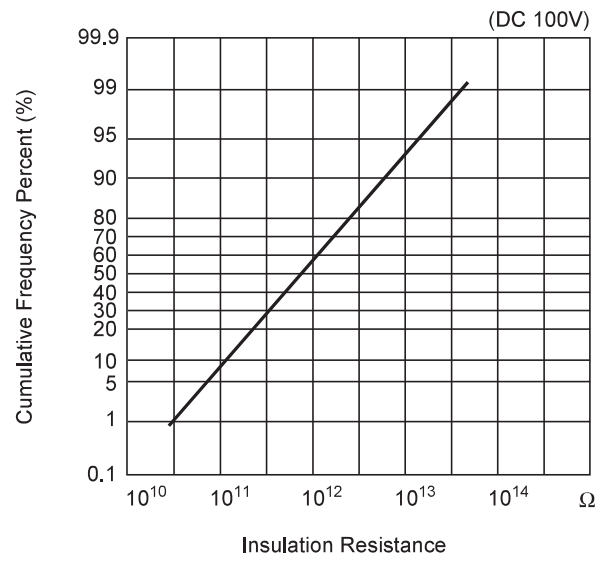

(5) Electrostatic Capacitance

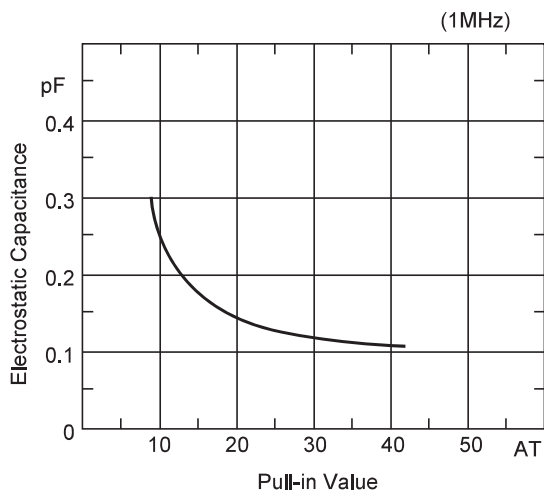

■ OPERATING CHARACTERISTICS

Parameter	Rated Value	Unit
Operate Time	0.4max	ms
Bounce Time	0.5max	ms
Release Time	0.05max	ms
Resonant Frequency	2750±250	Hz
Maximum Operating Frequency	500	Hz

(1) Operate Time

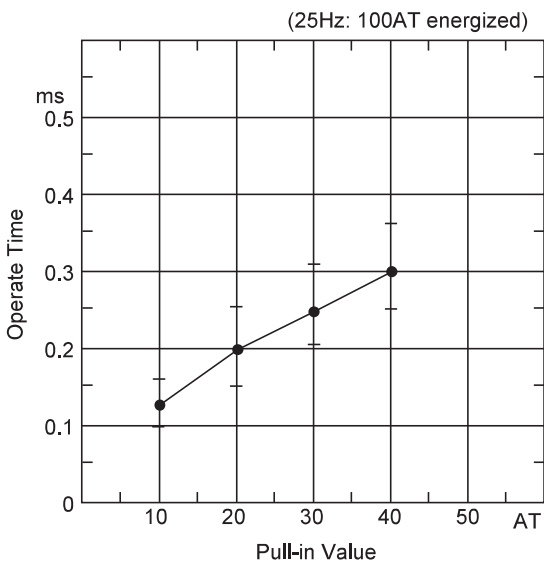

(2) Bounce Time

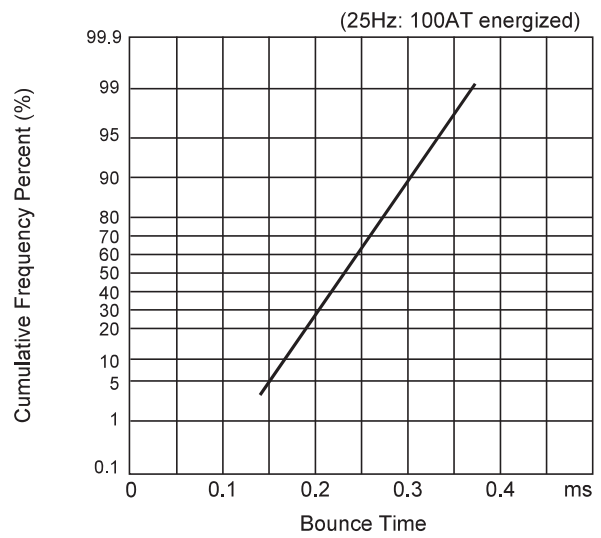

(3) Release Time

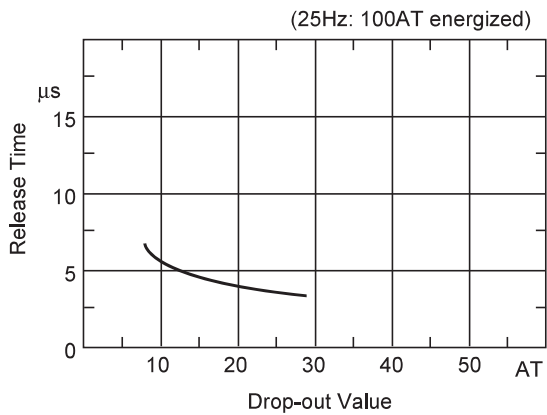

(4) Resonant Frequency

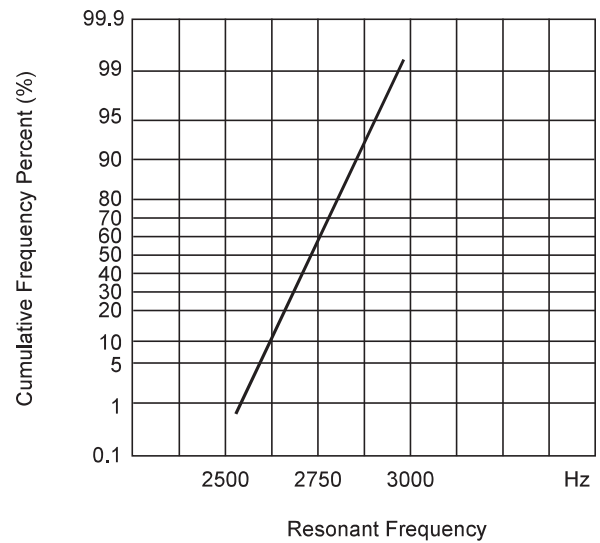

3

■ MECHANICAL CHARACTERISTICS

(1) Lead Tensile Test (Static Load)

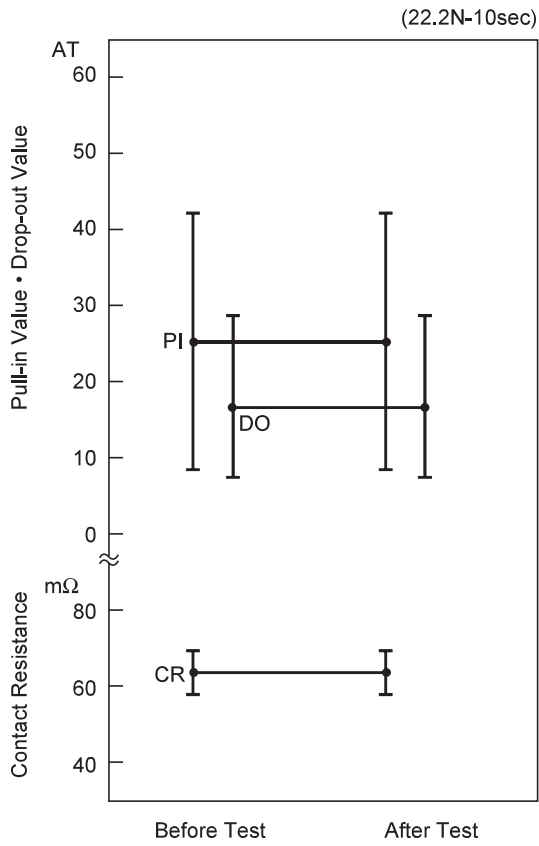

(2) Lead Tensile Strength

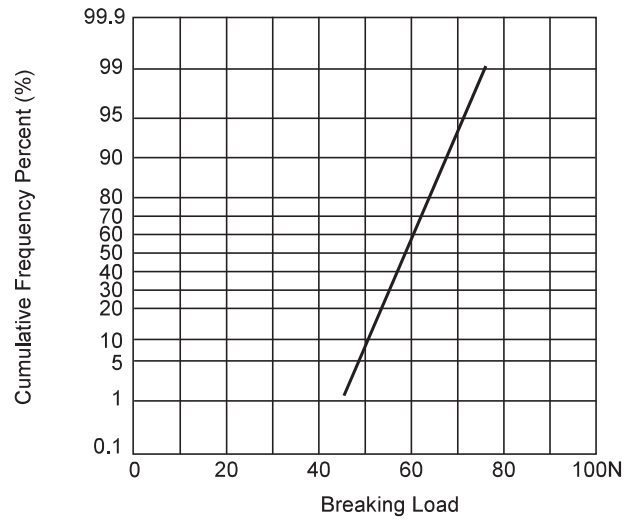

3

■ ENVIRONMENTAL CHARACTERISTICS

(1) Temperature Characteristics

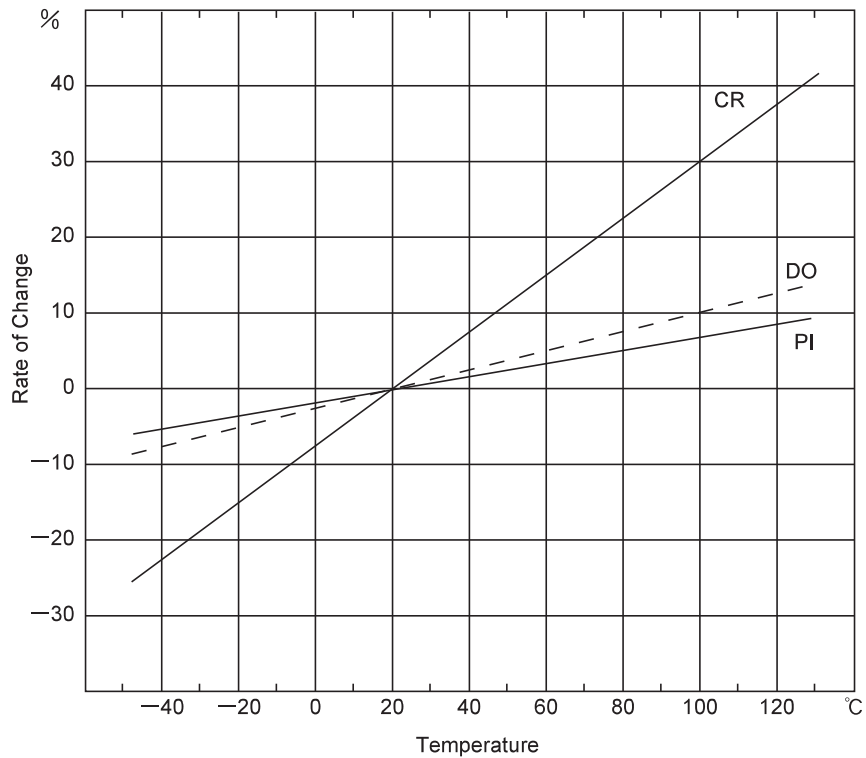

(2) Temperature Cycle

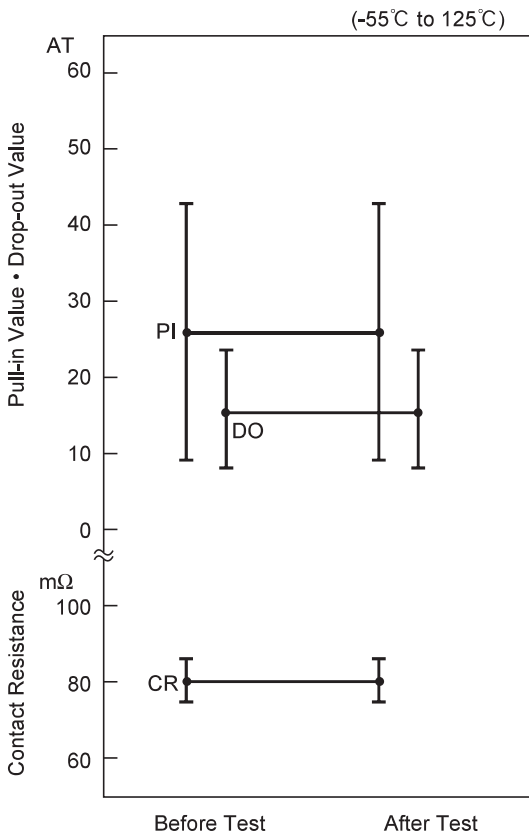

(3) Temperature and Humidity Cycle

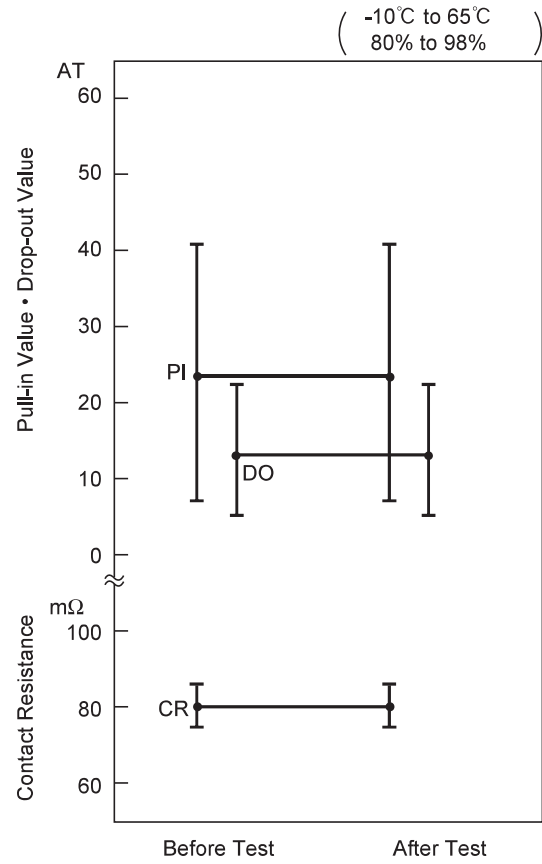

(4) High Temperature Storage Test

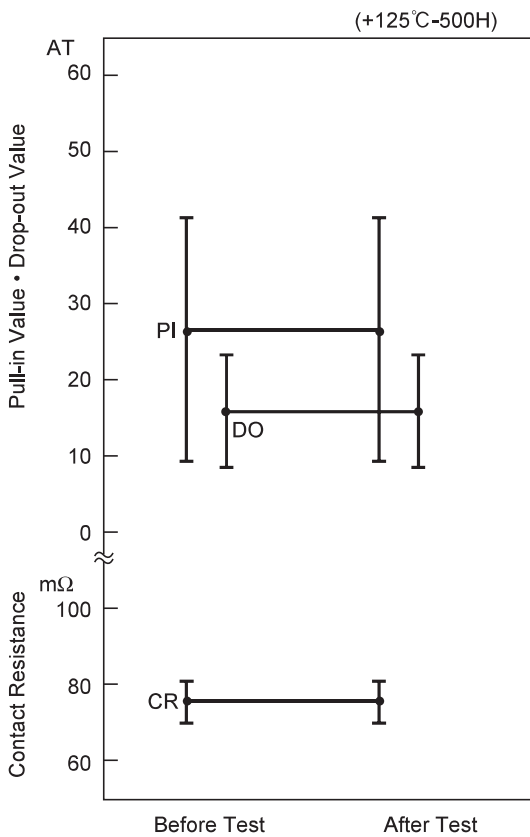

(5) Low Temperature Storage Test

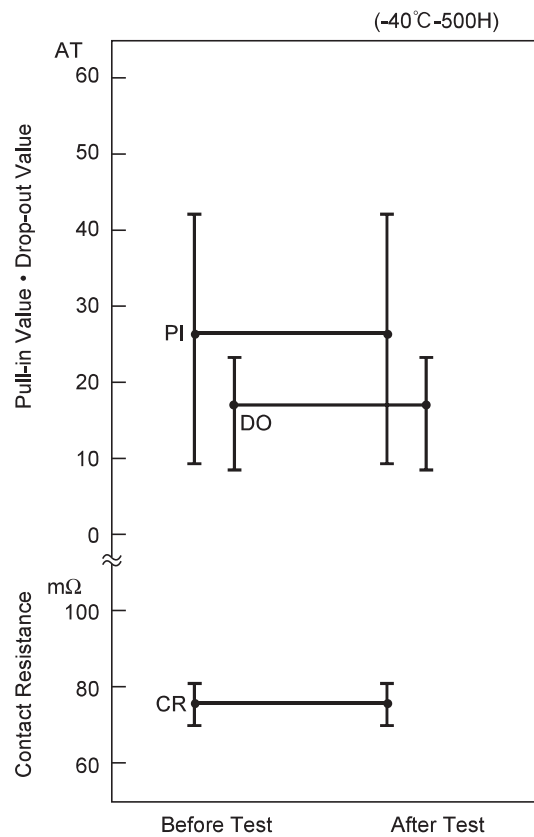

3

(6) Shock Test

1) Electrical Characteristics

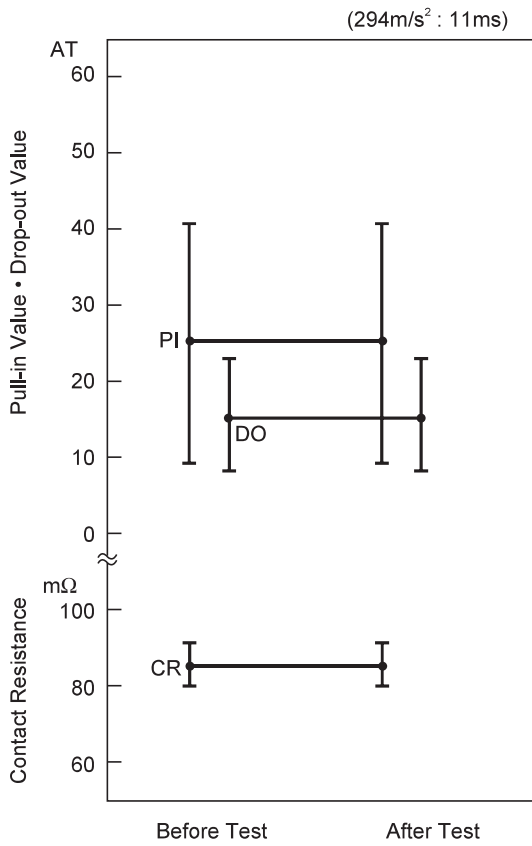

2) Misoperation Area

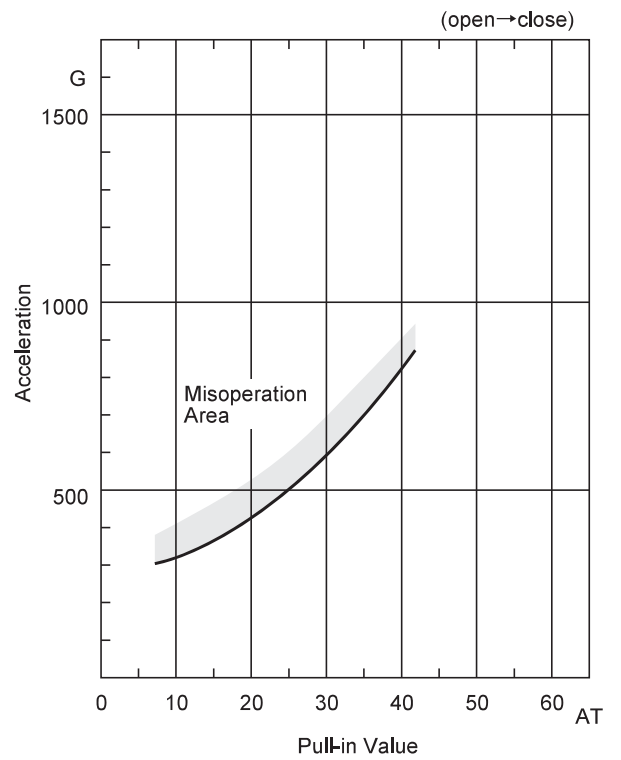

3

(7) Vibration Test

